

The OPTILUX light generators improve visual acuity through the use of a dynamic display mode, capable of rendering horizontal and vertical stripes with a sinusoidal light transitions. This feature fundamentally increases the topography visibility of defects for perceived quality, significantly reducing operator fatigue and discomfort during inspections. Furthermore, the continuous curvature of the dynamic displays allows the generation of regular & uninterrupted light patterns (adjustable in width) with progressive grey-level transitions, improving detection capabilities. The conjunction of these dynamic features,

Features:

- Dynamic & structured control of displayed light
- Continuous display curvature
- Adjustable stripes width
- V & H direction of stripes display
- Sinusoidal grey-level stripe transitions
- Closed loop display adapted for car displacement
- Simple and modular scalability

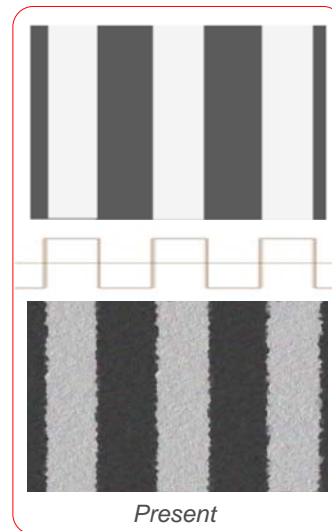

*Square screen profile (top)
Square reflected profile (bottom)*

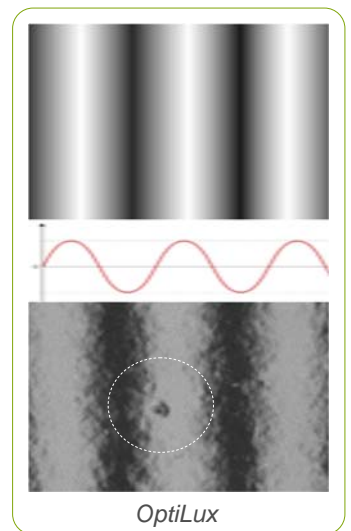

*Sinusoidal screen profile (top)
Sinusoidal reflected profile (bottom)*

Benefits

- Improved visual acuity through the use of a progressive (sinusoidal) transition
- The stripes width can be dynamically adapted to achieve the best detection sensitivity
- The multidirectional detection patterns enhance efficiency and provide more ergonomic working conditions
- The continuous screen curvature provides a smooth and regular stripe density distribution
- A display with a closed loop built compensates vehicle displacement, reduces stripes size and improves efficiency
- Modular light with adjustable settings (luminosity, contrast, frequency, color temperature...) for optimal detection
- A Phase-Shifting enabled display sets the foundation for an automated deflectometry measurement capacity

Optilux enhances detection efficiency and sensitivity for paint surface inspection

Dynamic light display, improving

Conventional technology

Conventional light inspection tunnels use static light sources with a fixed step between white and black stripe transitions. The stripes reflected effect. Stripes with narrower widths however greatly improve defect detection efficiency, particularly because detection is most efficient when the reflected light stripes, which is very strenuous for operators mentally, as they need to be highly concentrated to be able to follow the light transition to compensate for the inadequate static and wide light sources, which is physically tiresome and has an increasingly negative impact on the width, thus improving visual acuity as well as overall inspection performance. Another major disadvantage of current solutions is the irregularity efficient for defect detection. An issue which is further hampered due to the unidirectional pattern limitation. The Optilux technology is a breakthrough compromise. The pictures below highlight the limitations of conventional technology like brutal light transitions, areas without reflection, unidirectional



Optilux technology

The OptiLux technology offers several critical benefits, such as a LED-based screen with a continuous curvature, capable of displaying dynamic images for homogeneous density distribution of the reflected stripes. The ability to dynamically display horizontal or vertical stripe patterns with sinusoidal grey level light transitions, is the key factor for optimizing the efficiency and ergonomics of defect

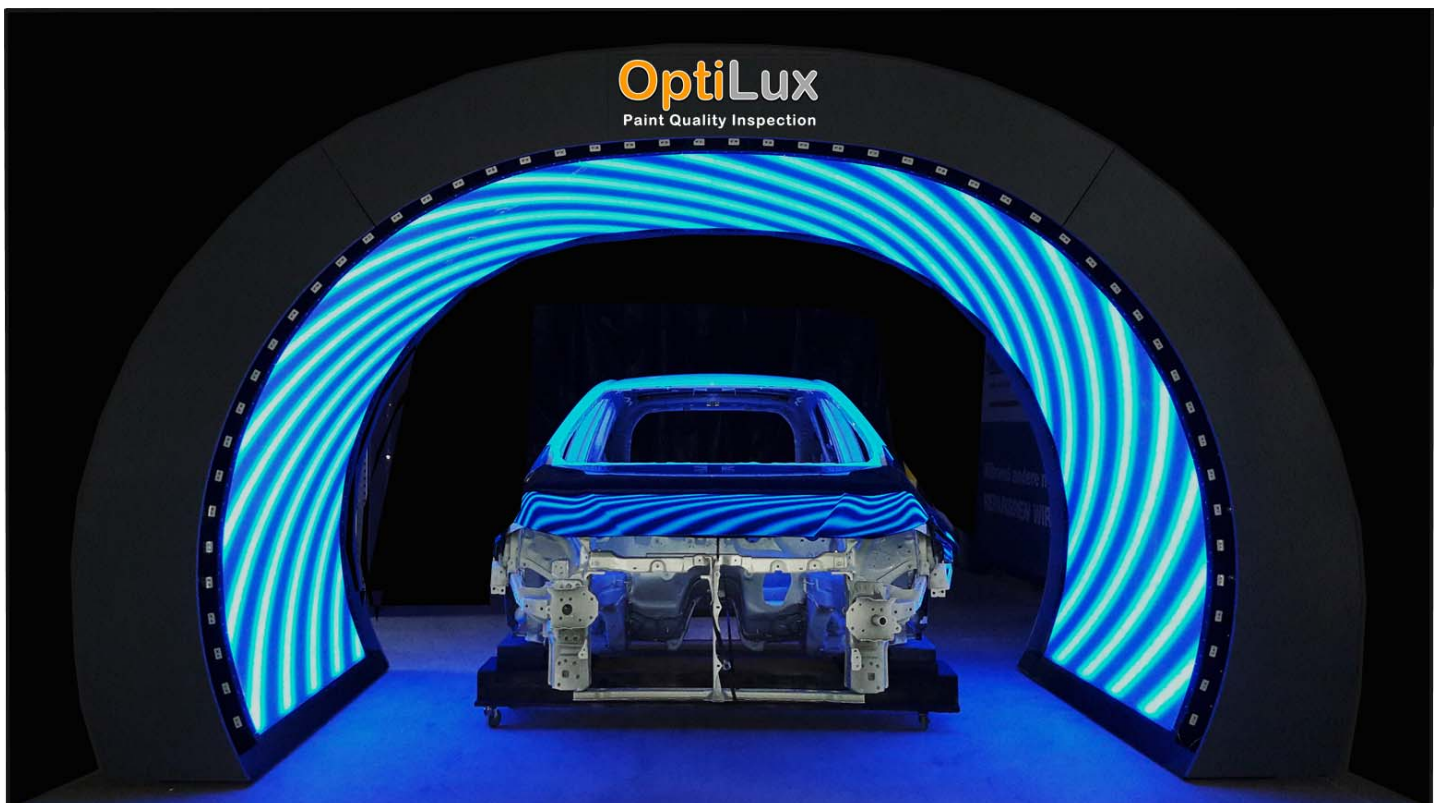

Audit station, Paint inspection tunnel or Final assembling inspection

*Sta
disp
strip*

*Dyn
disp
strip*

paint defect inspection efficiency

by the surface are moving with the vehicle's displacement, thus leading current solutions to use particularly wide stripes to compensate for this. The defect is seen in the light's sinusoidal grey level transition. The vehicle's displacement also creates a scanning effect as it moves through the stripes throughout the inspection process without interruptions. The operators also need to repeatedly move between a crouching and upright position to maximize their detection capabilities. Only a dynamic light source is able to eliminate these constraints, by allowing the adjustment of the displayed stripes' period and discontinuity found in static light distribution, created by the spacing of light box. This setup generates abrupt light transitions which is an efficient enough solution in the sense that it entirely surpasses these limitations, thus offering optimum efficiency and ergonomic working conditions without the need for additional stripe direction, rapid change in reflection due to the vehicles' displacement, irregular stripes distributions,...

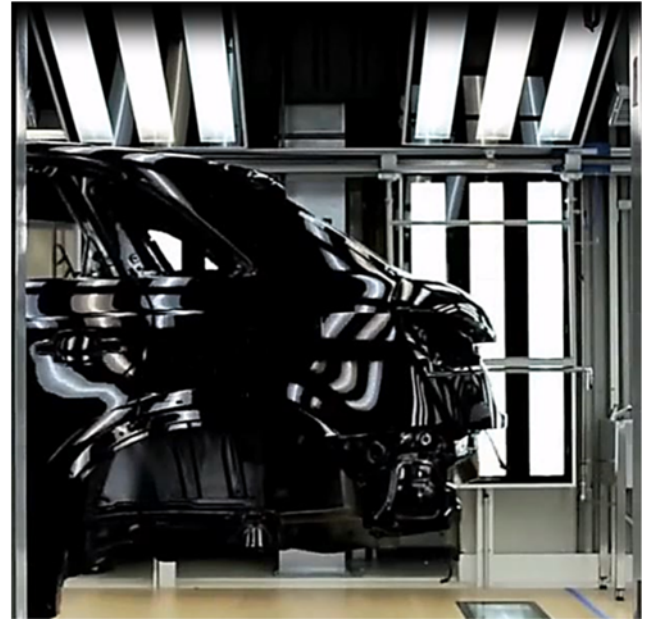

Dynamic lighting and closed loop display

A dynamic light display allows for a closed loop pattern display, specially fitted to accommodate a vehicle's displacement. This particularly reduces the scanning speed of the reflected pattern on the vehicle's surface during displacement. The first row of stripes shown below simulates the operator's view while observing a door panel using a static light display. The second row of stripes shown below simulates the operator's view while observing a door panel using a dynamic light display. With a dynamic display, for each movement of the vehicle, the stripes are moved in the same direction as the vehicle. This process reduces the number of periods an operator will perceive while observing the same inspection area. This compensating effect enables the use of narrower stripes, which in turn greatly increase the visual acuity and thus overall defect detection efficiency. The technology goes beyond purely improving the sinusoidal light transitions. The dynamic light technology sets the system apart, and establishes Optilux as a breakthrough solution for paint inspection.

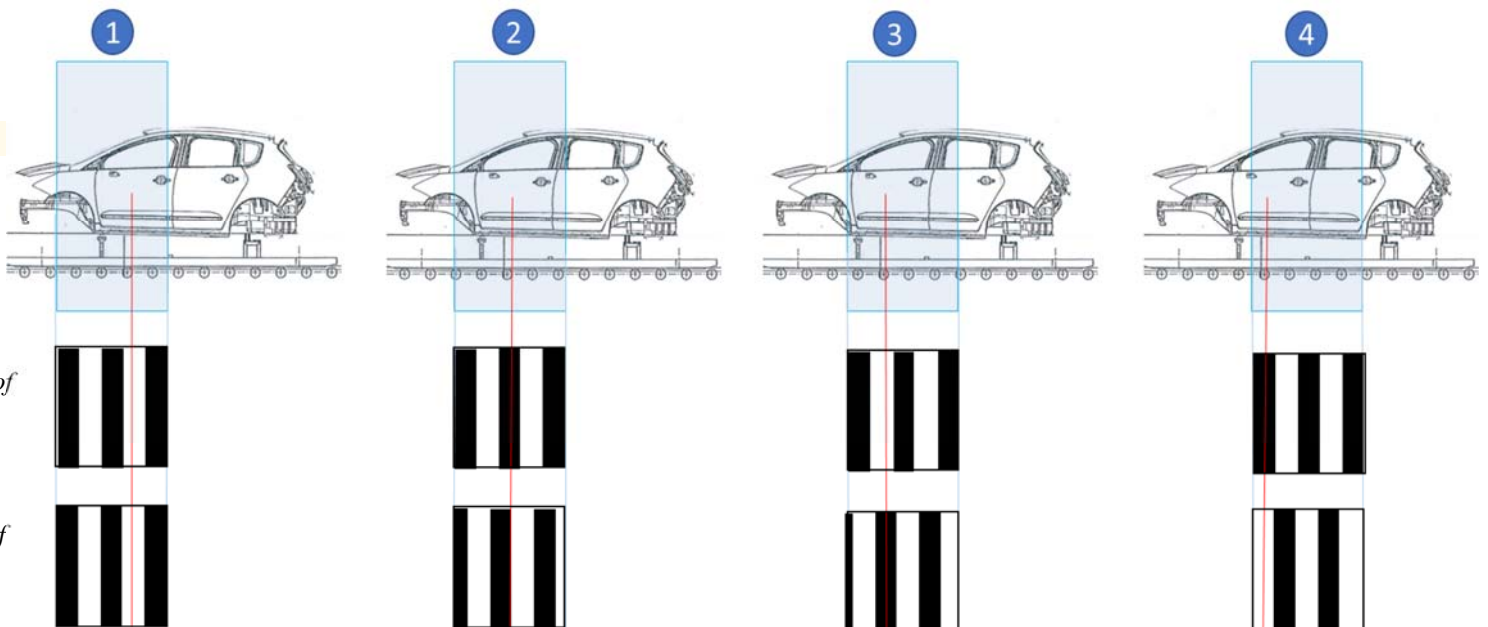

A dynamic stripe display enables the reduction of the stripes' period (width) for an improved detection efficiency

Benefits of the OptiLux Technology

Sinusoidal light transitions

Phase Shifting Deflectometry has largely demonstrated that defects are best visible in the gradient area found in the sinusoidal grey level transitions of light. The Optilux technology allows full control of the light's transition profiles which help highlight defects. A dynamic display sets the foundation for easy detection of even the smallest irregularities.

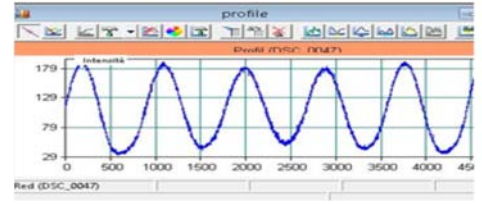

Sensitivity of defect detection

The image on the right shows a painted surface containing dust inclusion defects. Upon closer inspection, we clearly notice that defects appear more clearly defined in light transitions areas. The progressive light transition greatly improves defect detection, especially compared to the hard light transitions found in conventional light inspection tunnels using static light sources. The use of high resolution LED lighting offers full control and the ability to maximize the gradient in light transitions.

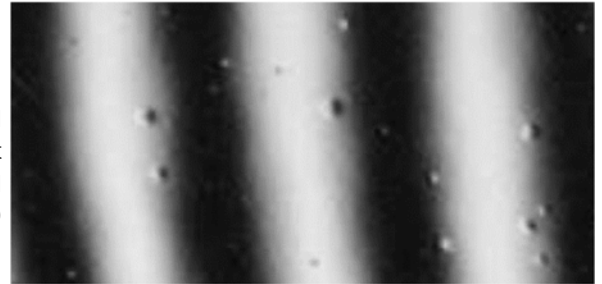

Step & direction of display

The capacity to change the direction of displayed pattern as well as the stripes' width has a direct impact on defect detection efficiency. Narrower stripes enable better detection sensitivity compared to larger stripe patterns. In fact, the narrower the stripes' width, the greater the eyes' spatial resolution which improves detection efficiency. (The opposite holds true as well)

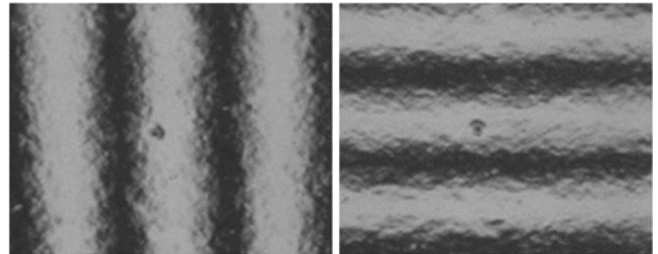



The ability to display multidirectional patterns is also an important factor that further improves defect detection. Some defects will be more visible using a horizontal or respectively vertical pattern, depending on the direction of the local curvature found on the vehicle's body surface. It is the combination of both features (width and direction) that provides unmatched detection results and detection comfort.

Remote control

The Optilux technology also allows operators to dynamically alter the parameters guiding the displayed pattern. The following parameters can be remotely modified and automatically saved for replay.



Display pattern: 

Display direction: 

Grey level transition: 

Reflected scanning speed: 

Pattern mode display: manual, automatic, statistical...